

LAYER® Product Brief



The 1st leading inkjet Printed Organic Photovoltaic Product : We are the first in the world to print with photovoltaic ink. With more than 10 years of experience, from the laboratory to the industrial stage.

Product Name

Demokit 06B dimensions

06_DKT_047x047_A5_B_R01

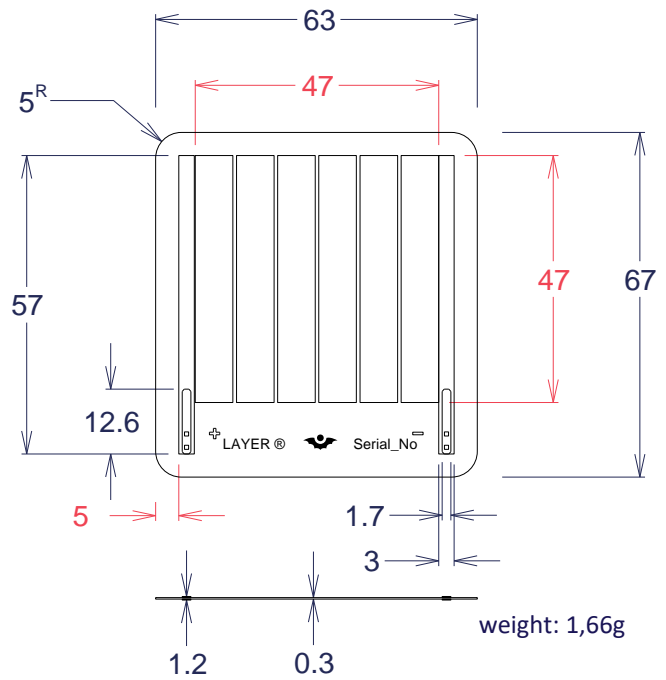
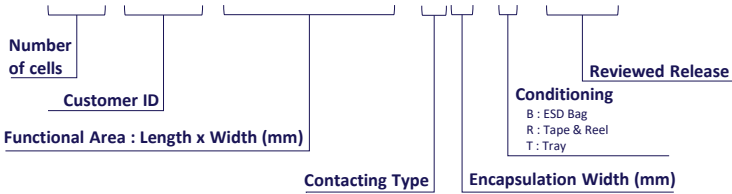

Contacting type



A
Crimp



Indoor

Wires can be soldered on it



B
Soldered wires

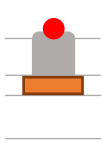

Indoor

Wires already soldered



C
Resin coating

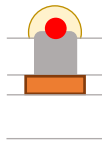

Outdoor

Wires already soldered
Resin coating prevents outdoor aggressions



D
Open via

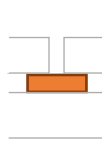

Indoor

Free contacting, advised conductive or soldering paste



E
Bump

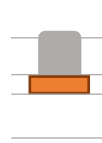

Indoor

Wires can be soldered on it



F
ZIF

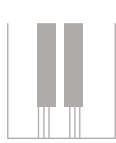

Indoor

Contact with ZIF connector



Demokit 06B Characteristics

Current - Voltage

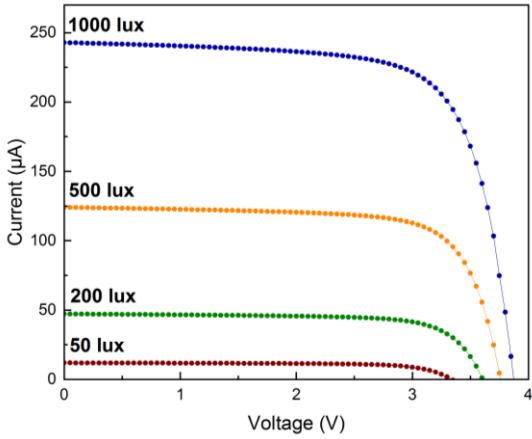

Power - Voltage

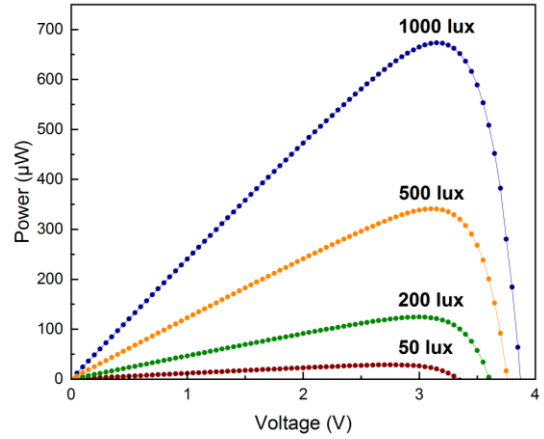

Illuminance dependency

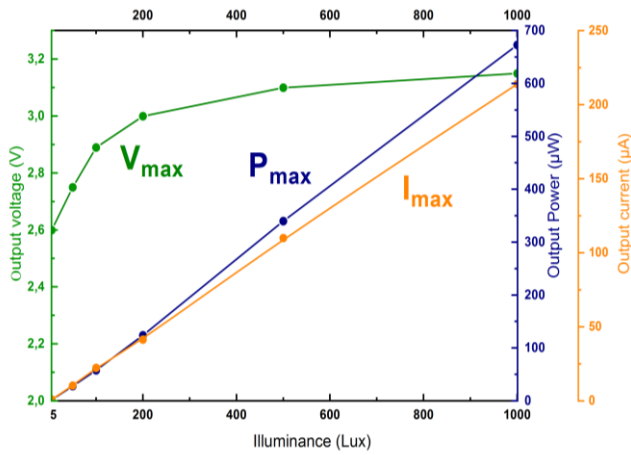

Light angle dependency

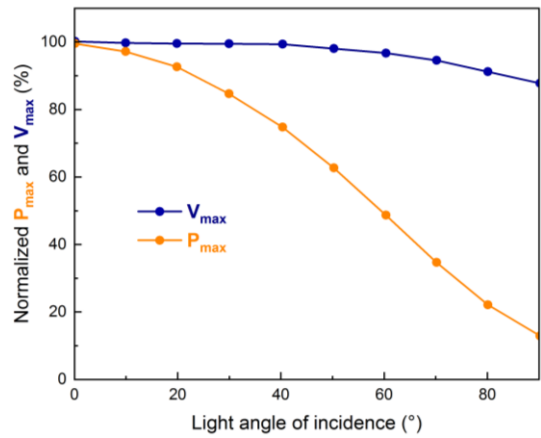

Temperature dependency

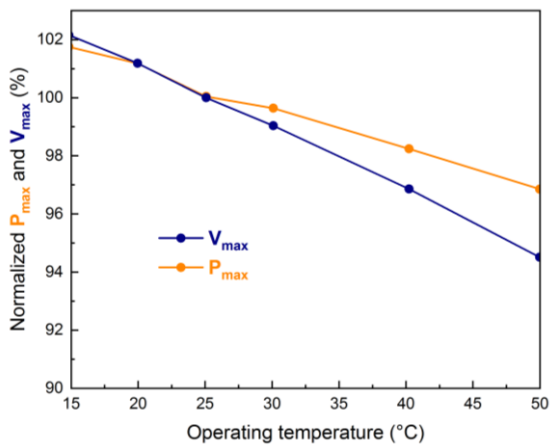

Indoor Aging (*)

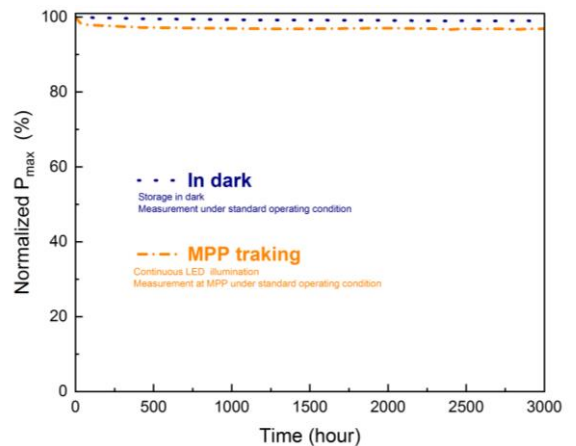

(*) done under standard operating condition



Demokit 06B Datasheet

Demokit 06B Electrical characteristics

Luminosity (lx)	Voc(V)	Isc(μA)	Vm(V)	Im(μA)	Pm(μW)
1000	3,7	245	2,85	200	570
500	3,65	130	2,8	105	294
200	3,4	55	2,7	45	121
50	3	13	2,35	10	23

Operating conditions

Item	Unit	Min	STD	Max
Surface temperature	°C	-40	25	40
Ambient humidity	%RH	1	50	90
Luminosity	lux	5	400	100K

Storage conditions

Item	Unit	Min	Max
Surface temperature	°C	-40	30
Ambient humidity	%RH	0	70
Luminosity	lux	Indoor conditions	

Handling and Safety

- During unloading and handling, gloves are required to prevent fingerprints or possible shocks.
- Handle panels with caution. Mechanical stress such as shocks and sharp pressures on the panel surface must be avoided to prevent delamination, scratching of the film, and internal structure damage.
- Do not bend over 2 cm radius.
- Avoid contact with chemicals such as solvents.
- For cleaning, gently wipe the surface of the panel with non-abrasive cloth.
- In case of breakage, do not swallow particles, chips, or materials.
- For interconnections, crimp contacts are recommended. Soldering and other interconnecting technologies which apply heat to the panel may cause damage.

